

Grilles, Registers & Diffusers

AIRTAG

Grilles, Registers & Diffusers

Lay-In 4-Way Diffuser

Face Size Metric	Face Size Imperial	Price
395 x 395 Face	N/A	
595 x 295 Face	N/A	
595 x 595 Face	N/A	
605 x 605 Face	N/A	

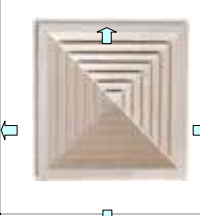

Lay-In 3-Way Diffuser

Face Size Metric	Face Size Imperial	Price
595 x 595 Face	N/A	

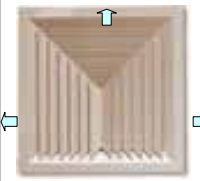

Lay-In 2-Way Opposite Blow Diffuser

Face Size Metric	Face Size Imperial	Price
595 x 595 Face	N/A	



Lay-In 2-Way Corner Blow Diffuser

Face Size Metric	Face Size Imperial	Price
595 x 595 Face	N/A	

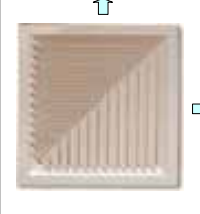

Lay-In 1-Way Blow Diffuser

Face Size Metric	Face Size Imperial	Price
595 x 595 Face	N/A	



Grilles are powder coated white as standard

Flush Face Diffusers continued on next page....

AIRTAG

Grilles, Registers & Diffusers

Flush Mounted 4-Way Blow Diffuser

Nom. Neck Metric	Nom. Neck Imperial	Price
150 x 150	6 x 6	
225 x 225	9 x 9	
300 x 300	12 x 12	
375 x 375	15 x 15	

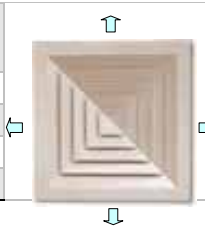

Flush Mounted 3-Way Blow Diffuser

Nom. Neck Metric	Nom. Neck Imperial	Price
150 x 150	6 x 6	
225 x 225	9 x 9	
300 x 300	12 x 12	
375 x 375	15 x 15	

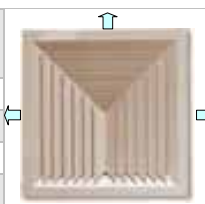

Grilles are powder coated white as standard

Square to Round Reducing Neck

Neck Size Metric	Neck Size Imperial	Price
450 x 450	18 x 18	

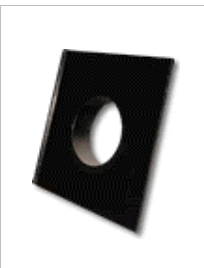

Square to Square Reducing Neck

Neck Size Metric	Neck Size Imperial	Price
450 x 450	18 x 18	



Plaster Board Frame

Product Code	Size Metric	Size Imperial	Pieces/ Carton	Price
PBF595	595 x 595	N/A	10	



Grilles are powder coated white as standard

AIRTAG

Grilles, Registers & Diffusers

Bevelled Edge 4-Way Blow Diffuser

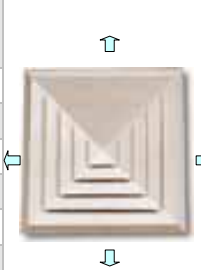
Nom. Neck Metric	Nom. Neck Imperial	Price	
150 x 150	6 x 6		
225 x 225	9 x 9		
300 x 300	12 x 12		
375 x 375	15 x 15		
450 x 450	18 x 18		
525 x 525	21 x 21		

Bevelled Edge 3-Way Blow Diffuser

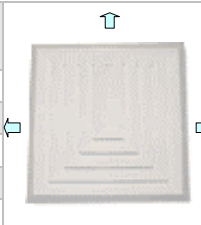
Nom. Neck Metric	Nom. Neck Imperial	Price	
150 x 150	6 x 6		
225 x 225	9 x 9		
300 x 300	12 x 12		
375 x 375	15 x 15		
450 x 450	18 x 18		

Bevelled Edge 2-Way Opposite Blow Diffuser

Nom. Neck Metric	Nom. Neck Imperial	Price	
225 x 225	9 x 9		
300 x 300	12 x 12		
375 x 375	15 x 15		
450 x 450	18 x 18		

Bevelled Edge 2-Way Corner Blow Diffuser

Nom. Neck Metric	Nom. Neck Imperial	Price	
225 x 225	9 x 9		
300 x 300	12 x 12		
375 x 375	15 x 15		
450 x 450	18 x 18		

Grilles are powder coated white as standard

Edge Diffusers continued on next page....

AIRTAG

Grilles, Registers & Diffusers

Bevelled Edge 1-Way Blow Diffuser

Nom. Neck Metric	Nom. Neck Imperial	Price
225 x 225	9 x 9	
300 x 300	12 x 12	
375 x 375	15 x 15	
450 x 450	18 x 18	



Bevelled Edge 3-Way Rectangular Diffuser

Nom. Neck Metric	Nom. Neck Imperial	Price
375 x 150	15 x 6	



Bevelled Edge 4-Way Rectangular Diffuser

Nom. Neck Metric	Nom. Neck Imperial	Price
450 x 225	18 x 9	



Grilles are powder coated white as standard

Fixing Clip Reducing Necks

Neck Size Metric	Neck Size Imperial	Price Plain Neck	Price Neck c/w BFD
150 x 150	6 x 6		
225 x 225	9 x 9		
300 x 300	12 x 12		
375 x 375	15 x 15		
375 x 150	15 x 6		
450 x 225	18 x 9		
450 x 450	18 x 18		
525 x 525	21 x 21		



**Fixing Clip Reducing Necks to suite Bevelled Edge Diffusers*
*All Reducing Necks sprayed black as standard**

AIRTAG

Grilles, Registers & Diffuser

THERMA-FUSER

Face Size Metric	Inlet Designation Imperial	Price
595 x 595	6	
595 x 595	8	
595 x 595	10	
595 x 595	12	



Grilles, Registers & Diffuser

Removable Core (20 mm) 2 Slot Linear Diffusers

Nom. Neck	Slot	Slot Width (mm)	<A> Face Size	 Face Size	<C>x<D> Act. Neck	Price
600	2	20	638	145	590 x 97	
900	2	20	938	145	890 x 97	
1200	2	20	1238	145	1190 x 97	
555	2	20	595	145	547 x 97	
1155	2	20	1195	145	1147 x 97	



Diffusers are powder coated white as standard

All RCLS come complete with safety chain

Linear Boxes to Suit Removable Core (20 mm) 2 Slot Linear Diffuser

Size	Price 5 mm Rubber	Price 13 mm Poly	Price 13 mm F/G	Price 25 mm F/G	Price 25 mm Perf
600 x 105					
900 x 105					
1200 x 105					
555 x 105					
1155 x 105					



**Stepped Linear Boxes to cover Insulation will be an additional*

Spigots are side entry as standard

AIRTAG

Grilles, Registers & Diffusers

Linear Slot Diffusers

Slot	Slot Width (mm)	Price
1	20	
2	20	
3	20	
4	20	
5	20	
6	20	
1	25	
2	25	
3	25	
4	25	
5	25	
6	25	
Any size available on request		



Bar Grilles

Nom. Neck Metric	Nom. Neck Imperial	Price
300 x 100	12 x 4	
300 x 150	12 x 6	
350 x 150	14 x 6	
400 x 150	16 x 6	
Any size available on request		



Grilles are powder coated white or precious silver pearl as standard

Available in Natural Anodised

Available in 15 deg or 0 deg deflection

Blade spacing available in 6 mm, 9.1 mm, 10.4 mm & 12.5 mm

Available in a 12 mm flange on request

Flangeless Bar Grilles available on request P.O.A

Floor Grilles

Nom. Neck Metric	Nom. Neck Imperial	Price
300 x 100	12 x 4	
300 x 150	12 x 6	
350 x 150	14 x 6	
400 x 150	16 x 6	
Any size available on request		



Floor grilles are manufactured with additional support

Grilles are powder coated white or beige as standard

Available in Natural Anodised

Available in 15 deg or 0 deg deflection

AIRTAG

Grilles, Registers & Diffusers

Jet Diffuser

Nom. Neck Metric	Nom. Neck Imperial	Price	
200	8		
250	10		
300	12		
350	14		
400	16		
<i>*Jet Diffusers available mounted to flat plate on request*</i>			
<i>*Grilles are powder coated white as standard*</i>			
<i>*If Jet Diffuser requires collar add</i>			

Jet Diffuser Flanged

Nom. Neck Metric	Nom. Neck Imperial	Price	
200	8		
250	10		
300	12		
350	14		
400	16		
<i>*Grilles are powder coated white as standard*</i>			

AIRTAG

Grilles, Registers & Diffusers

Round Diffusers – ABS

Nom. Neck Metric	Nom. Neck Imperial	Face Size Metric	Price
150	6	255	
200	8	320	
250	10	390	
300	12	435	

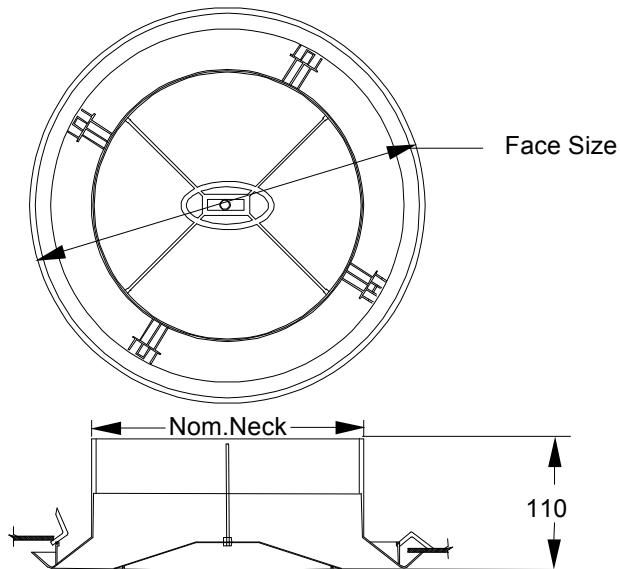

Eggcrate Round Diffuser – ABS

Product Code	Nom. Neck Metric	Nom. Neck Imperial	Price
ERND6	150	6	



AIRTAG

Grilles, Registers & Diffusers

Hinged Return Air Grilles c/w Filter

Nom. Neck Metric	Nom. Neck Imperial	Price
250 x 250	10 x 10	
300 x 300	12 x 12	
400 x 300	16 x 12	
600 x 300	24 x 12	
350 x 350	14 x 14	
400 x 350	16 x 14	
400 x 400	16 x 16	
500 x 400	20 x 16	
600 x 400	24 x 16	
700 x 400	28 x 16	
750 x 400	30 x 16	
900 x 400	36 x 16	
1000 x 400	40 x 16	
1200 x 400	48 x 16	
450 x 450	18 x 18	
600 x 450	24 x 18	
750 x 450	30 x 18	
900 x 450	36 x 18	
500 x 500	20 x 20	
600 x 500	24 x 20	
700 x 500	28 x 20	
750 x 500	30 x 20	
800 x 500	32 x 20	
900 x 500	36 x 20	
1000 x 500	40 x 20	
600 x 550	24 x 22	
650 x 550	26 x 22	
700 x 550	36 x 18	
750 x 550	30 x 22	
900 x 550	36 x 22	
600 x 600	24 x 24	
750 x 600	30 x 24	
900 x 600	36 x 24	
1200 x 600	48 x 24	



Any size available on request

Grilles are powder coated white as standard

All standard return air grilles with filter come standard with removable core

Hinged Return Air Grille c/w Filter continued on next page....

AIRTAG

Grilles, Registers & Diffusers

Hinged Return Air Grilles c/w Filter

Face Size Metric	Price	
595 x 295		
595 x 595		
605 x 605		
1195 x 595		
1210 x 605		
Any size available on request		
Grilles are powder coated white as standard *All standard return air grilles with filter come standard with removable core*		

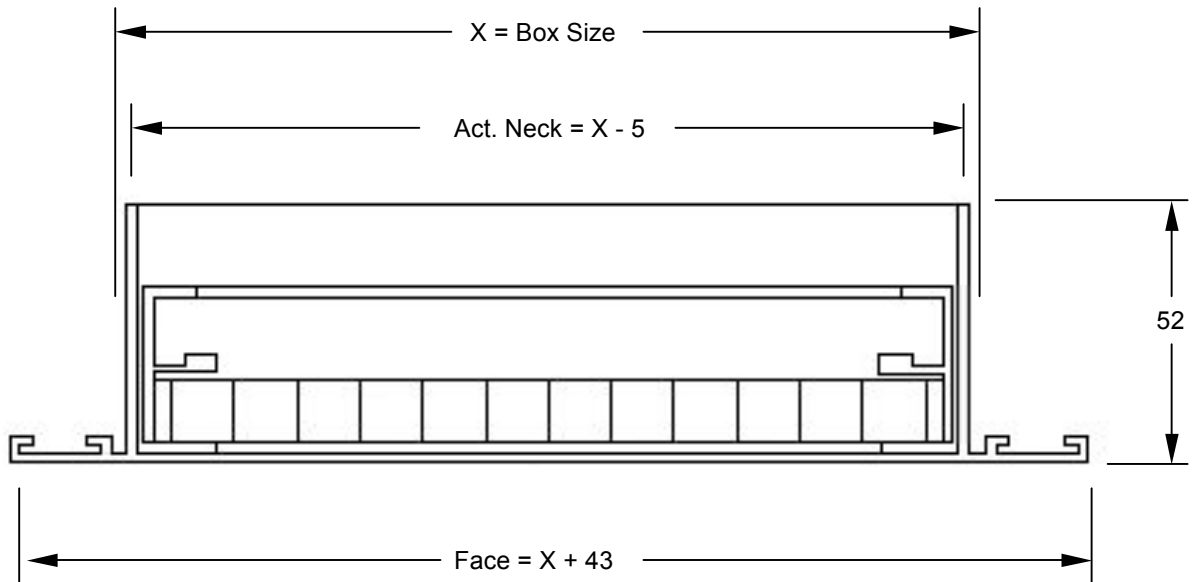

AIRTAG

Grilles, Registers & Diffusers

Eggcrate Grilles

Nom. Neck Metric	Nom. Neck Imperial	Price
150 x 150	6 x 6	
200 x 200	8 x 8	
225 x 225	9 x 9	
250 x 250	10 x 10	
300 x 300	12 x 12	
600 x 300	24 x 12	
350 x 350	14 x 14	
400 x 400	16 x 16	
600 x 400	24 x 16	
450 x 450	18 x 18	
500 x 500	20 x 20	
600 x 600	24 x 24	
595 x 295 Face	N/A	
595 x 595 Face	N/A	
605 x 605 Face	N/A	
1195 x 595 Face	N/A	
1210 x 605 Face	N/A	
Any size available on request		
Grilles are powder coated white as standard		



Fixing Clip Reducing Neck to Suit Eggcrate Grille

Product Code	Neck Size Metric	Neck Size Imperial	Price Plain Neck	Price c/w BFD
FCE66	150 x 150	6 x 6		
FCE88	200 x 200	8 x 8		
FCE99	225 x 225	9 x 9		
FCE1010	250 x 250	10 x 10		
FCE1212	300 x 300	12 x 12		
FCE1414	350 x 350	14 x 14		
FCE1616	400 x 400	16 x 16		
FCE1818	450 x 450	18 x 18		
FCE2020	500 x 500	20 x 20		
FCE2424	600 x 600	24 x 24		



AIRTAG

Grilles, Registers & Diffusers

Removable Core Eggcrate Grille

Nom. Neck Metric	Nom. Neck Imperial	<A> Face	 Face	<C>x<D> Act. Neck Metric	Price
150 x 150	6 x 6	190	190	142 x 142	
200 x 200	8 x 8	240	240	192 x 192	
250 x 250	10 x 10	290	290	242 x 242	
300 x 300	12 x 12	340	340	292 x 292	
350 x 350	14 x 14	390	390	342 x 342	
400 x 400	16 x 16	440	440	392 x 392	



Grilles are powder coated white as standard

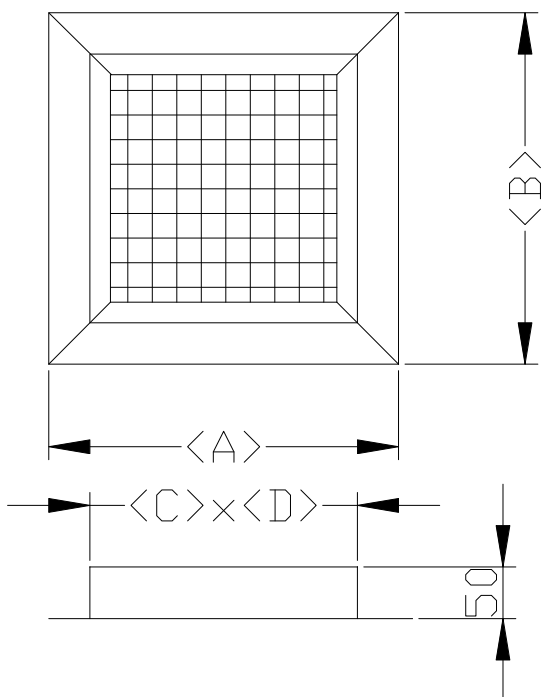

Eggcrate Core Only

Product Code	Nom. Neck Metric	Nom. Neck Imperial	Price
ECC595	595 x 595	N/A	
ECC1195595	1195 x 595	N/A	

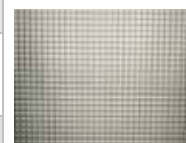

AIRTAG

Grilles, Registers & Diffusers

Double Deflection Register

Nom. Neck Metric	Nom. Neck Imperial	Price
250 x 100	10 x 4	
300 x 100	12 x 4	
350 x 100	14 x 4	
400 x 100	16 x 4	
450 x 100	18 x 4	
500 x 100	20 x 4	
600 x 100	24 x 4	
150 x 150	6 x 6	
200 x 150	8 x 6	
250 x 150	10 x 6	
300 x 150	12 x 6	
350 x 150	14 x 6	
400 x 150	16 x 6	
450 x 150	18 x 6	
500 x 150	20 x 6	
600 x 150	24 x 6	
750 x 150	30 x 6	
900 x 150	36 x 6	
200 x 200	8 x 8	
250 x 200	10 x 8	
300 x 200	12 x 8	
350 x 200	14 x 8	
400 x 200	16 x 8	
450 x 200	18 x 8	
500 x 200	20 x 8	
600 x 200	24 x 8	
750 x 200	30 x 8	
Any size available on request		
Grilles are powder coated white as standard		



Double Deflection Registers continued on next page....

AIRTAG

Grilles, Registers & Diffusers

Double Deflection Registers

Nom. Neck Metric	Nom. Neck Imperial	Price
300 x 250	12 x 10	
350 x 250	14 x 10	
400 x 250	16 x 10	
450 x 250	18 x 10	
500 x 250	20 x 10	
600 x 250	24 x 10	
300 x 300	12 x 12	
400 x 300	16 x 12	
600 x 300	24 x 12	
Any size available on request		
Grilles are powder coated white as standard		

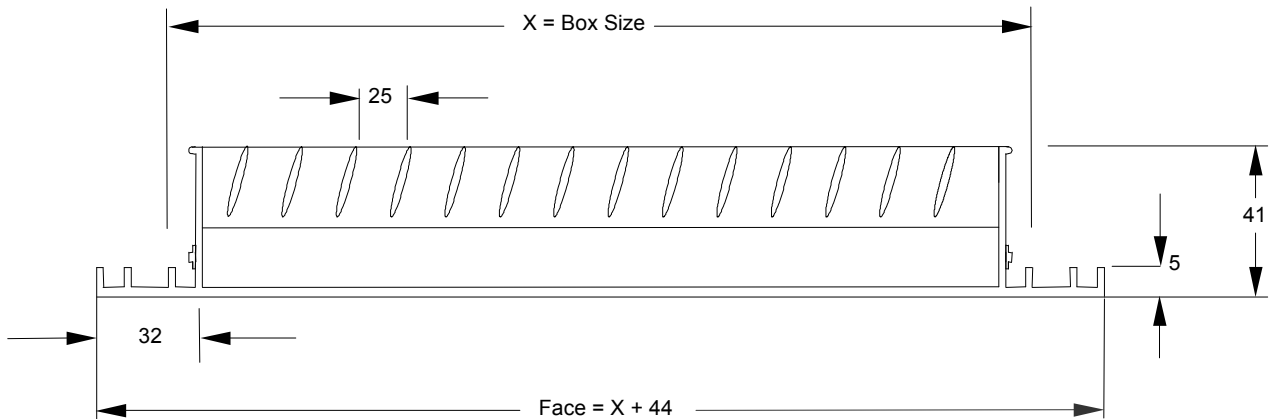
AIRTAG

Grilles, Registers & Diffusers

Removable Core Double Deflection Registers

Nom. Neck Metric	Nom. Neck Imperial	<A> Face	 Face	<C>x<D> Act. Neck	Price
300 x 100	12 x 4	340	140	292 x 92	
300 x 150	12 x 6	340	190	292 x 142	
350 x 100	14 x 4	390	140	342 x 92	
350 x 150	14 x 6	390	190	342 x 142	
350 x 200	14 x 8	390	240	342 x 192	
400 x 100	16 x 4	440	140	392 x 92	
400 x 150	16 x 6	440	190	392 x 142	
400 x 200	16 x 8	440	240	392 x 192	
450 x 150	18 x 6	490	190	442 x 142	
500 x 100	20 x 4	540	140	492 x 92	
500 x 150	20 x 6	540	190	492 x 142	
500 x 200	20 x 8	540	240	492 x 192	
600 x 100	24 x 4	640	140	592 x 92	
600 x 150	24 x 6	640	190	592 x 142	
600 x 200	24 x 8	640	240	592 x 192	



Grilles are powder coated white as standard

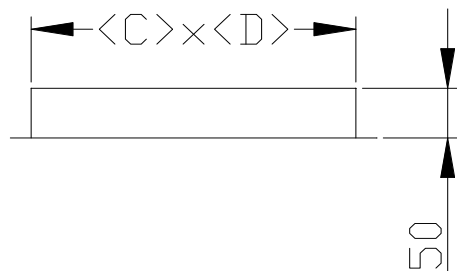
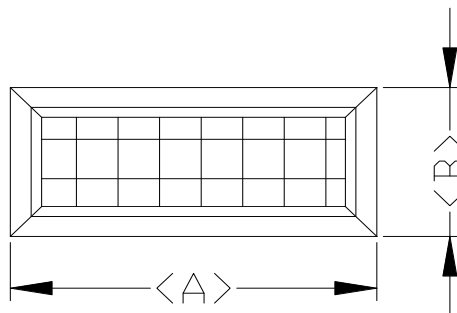

AIRTAG

Grilles, Registers & Diffusers

Weatherproof Louvre

Nom. Neck Metric	Nom. Neck Imperial	<A> FACE	 FACE	<C>x<D> ACT.NECK	Price
150 x 150	6 x 6	202	202	145 x 145	
200 x 200	8 x 8	250	252	195 x 195	
225 x 125	9 x 5	282	164	255 x 107	
225 x 175	9 x 7	282	214	255 x 157	
250 x 250	10 x 10	302	302	245 x 245	
300 x 300	12 x 12	352	352	295 x 295	
350 x 350	14 x 14	402	402	345 x 345	
400 x 400	16 x 16	452	452	395 x 395	
450 x 450	18 x 18	502	502	445 x 445	
500 x 500	20 x 20	552	552	495 x 495	
600 x 600	24 x 24	652	652	595 x 595	
Any size available on request					
Grilles are natural anodised as standard					

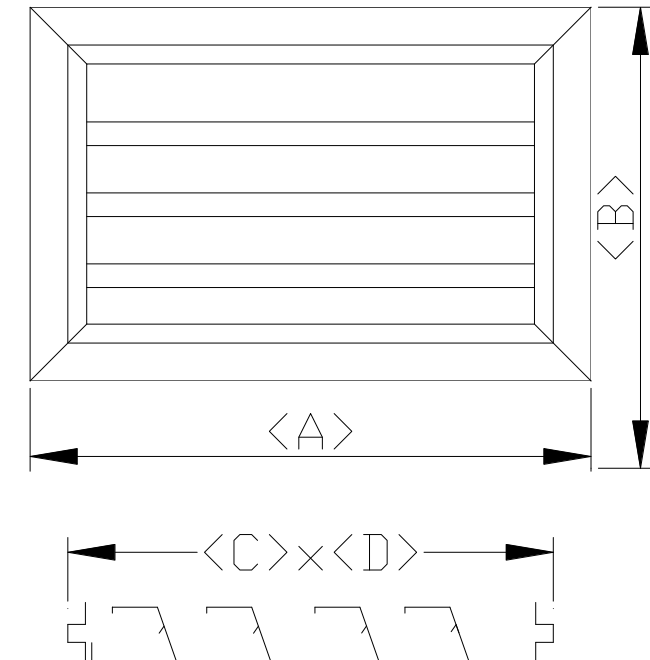

AIRTAG

Grilles, Registers & Diffusers

Half Chevron

Nom. Neck Metric	Nom. Neck Imperial	Price
225 x 175	9 x 7	
*		
<i>*Any size available on request</i>		



HC = HALF CHEVRON
 RCHC = REMOVABLE CORE HALF CHEVRON
 HCF = HALF CHEVRON/FILTER
 RCHCF = REMOVABLE CORE HALF CHEVRON/FILTER

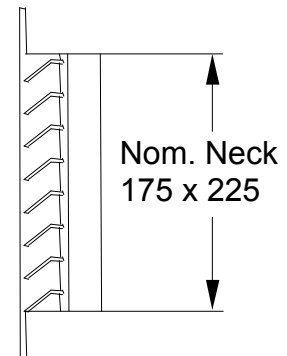
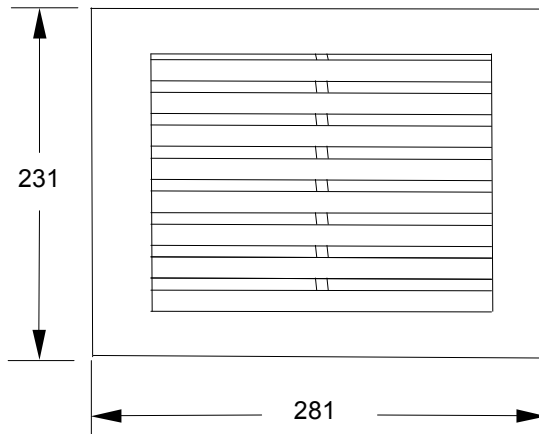

Snap on Box to suit Weatherproof Louvre/Half Chevron

Product Code	Size Metric	Size Imperial	Price
SOB95	225 x 125	9 x 5	
SOB97	225 x 175	9 x 7	
<i>*Easy to install with no drilling required*</i>			

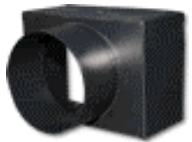

AIRTAG

Grilles, Registers & Diffusers

Door Grille

Nom. Neck Metric	Nom. Neck Imperial	Price
300 x 150	12 x 6	
450 x 150	18 x 6	
600 x 150	24 x 6	
600 x 200	24 x 8	
600 x 250	24 x 10	
600 x 300	24 x 12	
600 x 400	24 x 16	
600 x 450	24 x 18	
600 x 600	24 x 24	

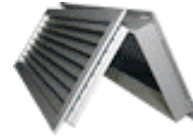

****Any size available on request****

****Easy snap together installation – No drilling required****

****Grilles are natural anodised as standard****

****To suit door thickness 30 – 45 mm****

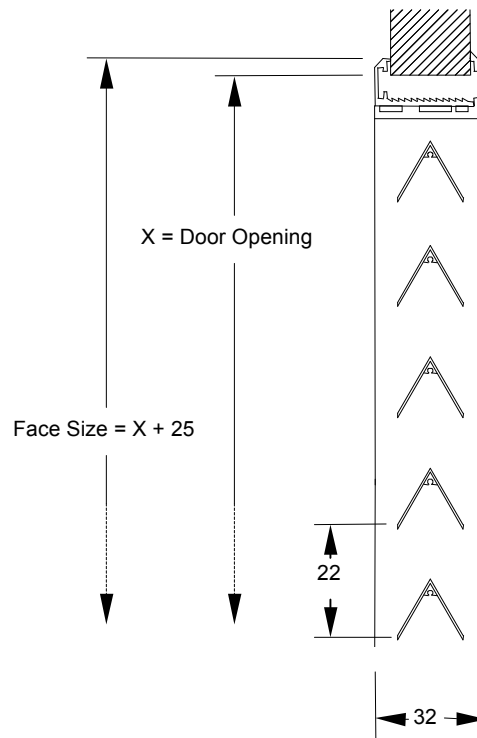

AIRTAG

Grilles, Registers & Diffusers

LVH-D Fire Door Kits

Standard Kit Sizes	Cover Grille Std Colour	Price
600 x 300 mm	Silver	
450 x 450 mm	Silver	

- Notes:**
- (i) Kits supplied complete with pair of cover grilles, Lorient Intumescent Mastic, Fixings and installation instructions.
 - (ii) Standard sizes only apply – up to two kits may be installed per door leaf if required
 - (iii) Kits suits both 35 and 45 mm thick fire door